

KEEX-2130

Industrial ECX Embedded SBC with Intel® Atom N270

User's Guide

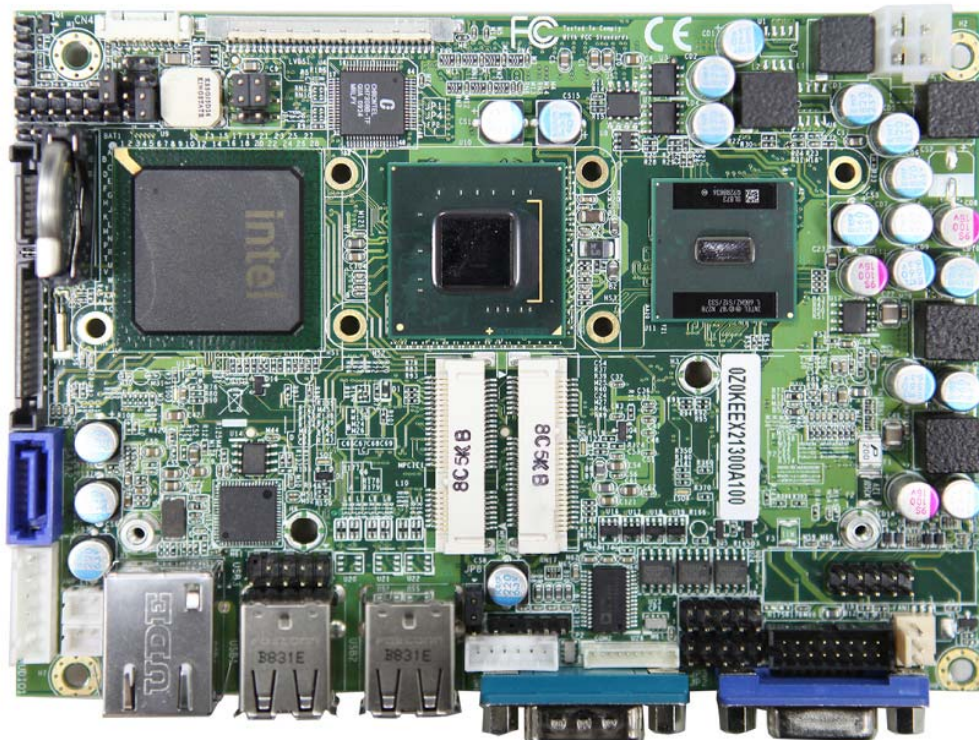

Contact Info: **Quanmax Inc.**
5F, No. 415, Ti-Ding Blvd. Sec. 2, NeiHu District,
Taipei, Taiwan 114
Tel: +886-2-2799-2789
Fax: +886-2-2799-7399

Visit our site at: **www.quanmax.com**

© 2008 Quanmax Inc. All rights reserved.

The information in this user's guide is provided for reference only. Quanmax does not assume any liability arising out of the application or use of the information or products described herein. This user's guide may contain or reference information and products protected by copyrights or patents and does not convey any license under the patent rights of Quanmax, nor the rights of others.

Quanmax is a registered trademark of Quanmax. All trademarks, registered trademarks, and trade names used in this user's guide are the property of their respective owners. All rights reserved. This user's guide contains information proprietary to Quanmax. Customers may reprint and use this user's guide in other publications. Customers may alter this user's guide and publish it only after they remove the Quanmax name, cover, and logo.

Quanmax reserves the right to make changes without notice in product or component design as warranted by evolution in user needs or progress in engineering or manufacturing technology.

Changes which affect the operation of the unit will be documented in the next revision of this user's guide.

Revision	Date	Edited by	Changes
1.0	2/24/2010	Chris	Initial Release
1.1	4/2/2010	Zack	Update Pin Out Definitions – LVDS/LAN/COM/Mini PCIE



Content

Content	3
Figures	4
Tables	5
Safety Instructions.....	7
Before You Begin	7
When Working Inside a Computer	7
Preventing Electrostatic Discharge.....	8
Preface.....	10
How to Use This Guide.....	10
Unpacking.....	10
Regulatory Compliance Statements	10
Warranty Policy	11
Maintaining Your Computer	12
Chapter 1 Introduction.....	15
Overview	15
Product Specifications	16
System Block Diagram	17
Mechanical Dimensions	18
Chapter 2 Hardware Settings	19
Overview	19
Jumper Settings and Pin Definitions	20
Jumper Settings	21
Rear Panel Pin Assignments.....	22
Main Board Pin Assignments.....	24
Chapter 3 System Installation	31
Memory Module Installation	31
Chapter 4 AMI BIOS Setup.....	33
Overview	33
Main Menu.....	34
Advanced Menu	35
Boot Menu	39
Chipset Menu	40
Power Menu.....	42
Security Menu.....	43
Exit Menu	44
Chapter 5 Driver Installation.....	46
Appendix A Digital IO Sample Code.....	47
Appendix B Watchdog Timer Sample Code	48

Figures

Figure 1 Block Diagram.....	17
Figure 2 Mechanical Dimensions.....	18
Figure 3 Jumper Connector	19
Figure 4 Jumper and Connector Locations.....	20
Figure 5 Align the SO-DIMM Memory Module with the onboard socket	31
Figure 6 Press down on the SO-DIMM Memory Module to lock it in place.....	31

Tables

Table 1 KEEEX-2130 Specification.....	16
Table 2 Jumper List	21
Table 3 JP2, JP3:COM Port Signal / Power Selection	21
Table 4 JP1 Clear CMOS Selection	21
Table 5 JP5 Backlight Enable Selection.....	21
Table 6 JP6 Backlight & Panel Power Selection.....	22
Table 7 JP7 Power Mode Selection.....	22
Table 8 JP8 Mini-PCIE Revision Selection	22
Table 9 Rear Panel Connector List.....	22
Table 10 LAN1:10/100/1000 Ethernet RJ-45 Connector(KEEX-2130)	22
Table 11 J1:Audio phone jack(KEEX-2131).....	23
Table 12 USB1,USB2:2-Stack USB2.0 Type A Connector	23
Table 13 COM1:RS-232 Port 1 DB-9 Connector.....	23
Table 14 VGA1:CRT DB-15 Connector	23
Table 15 Connector List	24
Table 16 ATX1 +12V Power Input Connector	24
Table 17 JP1:Wireless LAN LED	24
Table 18 CN1:PS/2 KB/MS Output Wafer	25
Table 19 CN2:Digital Input / Output Pin Header(KEEX-2130)	25
Table 20 CN2:Digital Input / Output Pin Header(KEEX-2131)	25
Table 21 CN3:VGA BOX HEADER.....	25
Table 22 CN4:LCD Inverter Output Wafer.....	26
Table 23 DIMM1:DDR2 Memory SO-DIMM Socket.....	26
Table 24 FP1:Front Panel 1 Pin Header	26
Table 25 FP2:Front Panel 2 Pin Header	26
Table 26 LVDS1:LVDS Panel Connector.....	26
Table 27 AUDIO1:CD-ROM Audio Input Wafer	27
Table 28 MPCIE1,MPCIE2:Mini PCIE slots.....	27
Table 29 MPCIE3 SIM card Wafer.....	28
Table 30 USB3:USB2.0 Port 4, 5 Pin Header	28
Table 31 CFD1:CF Type II Connector	28
Table 32 SATA1:Serial ATA & HDD Power Connector	29
Table 33 SATA2: SATA Connector	29
Table 34 AMP_R1:Audio AMP Right Output Wafer.....	29

Tables

Table 35 AMP_L1:Audio AMP Left Output Wafer.....	29
Table 36 FAN1:FAN Wafer.....	29
Table 37 COM2:RS-232 Port B Wafer.....	30
Table 38 BIOS Main Menu	34
Table 39 IDE Device Setting Menu	34
Table 40 System Information.....	35
Table 41 Advanced Menu	35
Table 42 Onboard I/O Configuration	36
Table 43 OnBoard Peripherals Configuration Settings.....	37
Table 44 Hardware Health Configuration.....	38
Table 45 Boot Menu.....	39
Table 46 Chipset Menu	40
Table 47 Video Function Configuration.....	41
Table 48 Power Menu	42
Table 49 Security Menu	43
Table 50 Exit Menu.....	44

Safety Instructions

■ Before You Begin

Before handling the product, read the instructions and safety guidelines on the following pages to prevent damage to the product and to ensure your own personal safety. Refer to the “Advisories” section in the Preface for advisory conventions used in this user’s guide, including the distinction between Warnings, Cautions, Important Notes, and Notes.

- Always use caution when handling/operating a computer. Only qualified, experienced, authorized electronics service personnel should access the interior of a computer. The power supplies produce high voltages and energy hazards, which can cause bodily harm.
- Use extreme caution when installing or removing components. Refer to the installation instructions in this user’s guide for precautions and procedures. If you have any questions, please contact Quanmax Post-Sales Technical Support.

WARNING



High voltages are present inside the chassis when the unit’s power cord is plugged into an electrical outlet. Turn off system power, turn off the power supply, and then disconnect the power cord from its source before removing the chassis cover. Turning off the system power switch does not remove power to components.

■ When Working Inside a Computer

Before taking covers off a computer, perform the following steps:

1. Turn off the computer and any peripherals.
2. Disconnect the computer and peripherals from their power sources or subsystems to prevent electric shock or system board damage. This does not apply when hot swapping parts.

3. Follow the guidelines provided in “Preventing Electrostatic Discharge” on the following page.
4. Disconnect any telephone or telecommunications lines from the computer.

In addition, take note of these safety guidelines when appropriate:

- To help avoid possible damage to system boards, wait five seconds after turning off the computer before removing a component, removing a system board, or disconnecting a peripheral device from the computer.
- When you disconnect a cable, pull on its connector or on its strain-relief loop, not on the cable itself. Some cables have a connector with locking tabs. If you are disconnecting this type of cable, press in on the locking tabs before disconnecting the cable. As you pull connectors apart, keep them evenly aligned to avoid bending any connector pins. Also, before connecting a cable, make sure both connectors are correctly oriented and aligned.

CAUTION



Do not attempt to service the system yourself except as explained in this user's guide. Follow installation and troubleshooting instructions closely.

■ Preventing Electrostatic Discharge

Static electricity can harm system boards. Perform service at an ESD workstation and follow proper ESD procedure to reduce the risk of damage to components. Quanmax strongly encourages you to follow proper ESD procedure, which can include wrist straps and smocks, when servicing equipment.

You can also take the following steps to prevent damage from electrostatic discharge (ESD):

- When unpacking a static-sensitive component from its shipping carton, do not remove the component's antistatic packing material until you are ready to install the component in a computer. Just before unwrapping the antistatic packaging, be sure you are at an ESD workstation or grounded. This will discharge any static electricity that may have built up in your body.
- When transporting a sensitive component, first place it in an antistatic container

or packaging.

- Handle all sensitive components at an ESD workstation. If possible, use antistatic floor pads and workbench pads.
- Handle components and boards with care. Don't touch the components or contacts on a board. Hold a board by its edges or by its metal mounting bracket.
- Do not handle or store system boards near strong electrostatic, electromagnetic, magnetic, or radioactive fields.

Preface

■ How to Use This Guide

This guide is designed to be used as step-by-step instructions for installation, and as a reference for operation, troubleshooting, and upgrades.

NOTE



Driver downloads and additional information are available under Downloads on our web site: www.quanmax.com.

■ Unpacking

When unpacking, follow these steps:

1. After opening the box, save it and the packing material for possible future shipment.
2. Remove all items from the box. If any items listed on the purchase order are missing, notify Quanmax customer service immediately.
3. Inspect the product for damage. If there is damage, notify Quanmax customer service immediately. Refer to “Warranty Policy” for the return procedure.

■ Regulatory Compliance Statements

This section provides the FCC compliance statement for Class A devices.

FCC Compliance Statement for Class A Devices

The product(s) described in this user’s guide has been tested and found to comply with the limits for a Class A digital device, pursuant to Part 15 of the FCC Rules. These limits are designed to provide reasonable protection against harmful

interference when the equipment is operated in a commercial environment. This equipment generates, uses, and can radiate radio frequency energy and, if not installed and used in accordance with the user's guide, may cause harmful interference to radio communications. Operation of this equipment in a residential area (domestic environment) is likely to cause harmful interference, in which case the user will be required to correct the interference (take adequate measures) at their own expense.

Changes or modifications not expressly approved by Quanmax could void the user's authority to operate the equipment.

NOTE



The assembler of a personal computer system may be required to test the system and/or make necessary modifications if a system is found to cause harmful interference or to be noncompliant with the appropriate standards for its intended use.

■ Warranty Policy

Limited Warranty

Quanmax Inc.'s detailed Limited Warranty policy can be found under Support at www.quanmax.com. Please consult your distributor for warranty verification.

The limited warranty is void if the product has been subjected to alteration, neglect, misuse, or abuse; if any repairs have been attempted by anyone other than Quanmax or its authorized agent; or if the failure is caused by accident, acts of God, or other causes beyond the control of Quanmax or the manufacturer. Neglect, misuse, and abuse shall include any installation, operation, or maintenance of the product other than in accordance with the user's guide.

No agent, dealer, distributor, service company, or other party is authorized to change, modify, or extend the terms of this Limited Warranty in any manner whatsoever. Quanmax reserves the right to make changes or improvements in any product without incurring any obligation to similarly alter products previously purchased.

Return Procedure

For any Limited Warranty return, please contact Support at www.quanmax.com and

login to obtain a Return Material Authorization (RMA) Number. If you do not have an account, send an email to support@quanmax.com to apply for one.

All product(s) returned to Quanmax for service or credit must be accompanied by a Return Material Authorization (RMA) Number. Freight on all returned items must be prepaid by the customer who is responsible for any loss or damage caused by common carrier in transit. Returns for Warranty must include a Failure Report for each unit, by serial number(s), as well as a copy of the original invoice showing the date of purchase.

To reduce risk of damage, returns of product must be in a Quanmax shipping container. If the original container has been lost or damaged, new shipping containers may be obtained from Quanmax Customer Service at a nominal cost. Quanmax owns all parts removed from repaired products. Quanmax uses new and reconditioned parts made by various manufacturers in performing warranty repairs and building replacement products. If Quanmax repairs or replaces a product, its warranty term is not extended.

Shipments not in compliance with this Limited Warranty Return Policy will not be accepted by Quanmax.

Limitation of Liability

In no event shall Quanmax be liable for any defect in hardware, software, loss, or inadequacy of data of any kind, or for any direct, indirect, incidental, or consequential damages in connection with or arising out of the performance or use of any product furnished hereunder. Quanmax's liability shall in no event exceed the purchase price of the product purchased hereunder. The foregoing limitation of liability shall be equally applicable to any service provided by Quanmax or its authorized agent.

■ Maintaining Your Computer

Environmental Factors

■ Temperature

The ambient temperature within an enclosure may be greater than room ambient temperature. Installation in an enclosure should be such that the amount of air flow required for safe operation is not compromised.

Consideration should be given to the maximum rated ambient temperature.

Overheating can cause a variety of problems, including premature aging and failure of chips or mechanical failure of devices.

If the system has been exposed to abnormally cold temperatures, allow a two-hour warm-up period to bring it up to normal operating temperature before turning it on. Failure to do so may cause damage to internal components, particularly the hard disk drive.

■ **Humidity**

High-humidity can cause moisture to enter and accumulate in the system. This moisture can cause corrosion of internal components and degrade such properties as electrical resistance and thermal conductivity. Extreme moisture buildup inside the system can result in electrical shorts, which can cause serious damage to the system.

Buildings in which climate is controlled usually maintain an acceptable level of humidity for system equipment. However, if a system is located in an unusually humid location, a dehumidifier can be used to maintain the humidity within an acceptable range. Refer to the “Specifications” section of this user’s guide for the operating and storage humidity specifications.

■ **Altitude**

Operating a system at a high altitude (low pressure) reduces the efficiency of the cooling fans to cool the system. This can cause electrical problems related to arcing and corona effects. This condition can also cause sealed components with internal pressure, such as electrolytic capacitors, to fail or perform at reduced efficiency.

Power Protection

The greatest threats to a system’s supply of power are power loss, power spikes, and power surges caused by electrical storms, which interrupt system operation and/or damage system components. To protect your system, always properly ground power cables and one of the following devices.

■ **Surge Protector**

Surge protectors are available in a variety of types and usually provide a level of protection proportional with the cost of the device. Surge protectors prevent voltage spikes from entering a system through the AC power cord. Surge protectors, however, do not offer protection against brownouts, which occur when the voltage drops more than 20 percent below the normal AC line voltage level.

■ **Line Conditioner**

Line conditioners go beyond the overvoltage protection of surge protectors. Line conditioners keep a system's AC power source voltage at a fairly constant level and, therefore, can handle brownouts. Because of this added protection, line conditioners cost more than surge protectors. However, line conditioners cannot protect against a complete loss of power.

■ **Uninterruptible Power Supply**

Uninterruptible power supply (UPS) systems offer the most complete protection against variations on power because they use battery power to keep the server running when AC power is lost. The battery is charged by the AC power while it is available, so when AC power is lost, the battery can provide power to the system for a limited amount of time, depending on the UPS system.

UPS systems range in price from a few hundred dollars to several thousand dollars, with the more expensive units allowing you to run larger systems for a longer period of time when AC power is lost. UPS systems that provide only 5 minutes of battery power let you conduct an orderly shutdown of the system, but are not intended to provide continued operation. Surge protectors should be used with all UPS systems, and the UPS system should be Underwriters Laboratories (UL) safety approved.

Chapter 1

Introduction

■ Overview

The KEEX-2130 is an ECX Form Factor embedded single board computer (SBC) that combines the high performance and low power consumption of the Intel® Atom™ processor with Intel® 945GSE/ ICH7M chipset and supports DDR2 400/533 SODIMM up to 2GB. This SBC offers the latest performance, features and I/O interfaces at an extremely attractive price/performance ratio and measures 105mm x 146mm, a 75 percent space reduction over micro-ATX boards. The KEEX-2130 features VGA and 18/24-bit dual channel LVDS panel support, SATA, RS-232/422/485 serial port, Digital I/O, Gb/s Ethernet, USB 2.0, keyboard/mouse, and HD audio.

Checklist

- SATA cable
- Y cable for keyboard & mouse
- Driver/ Manual CD
- Quick Installation Guide
- KEEX-2130 ECX motherboard

Features

- Intel® Atom Processor N270
- Intel® 945GSE / ICH7-M
- DDR2 SO-DIMM Socket, total up to 2 GB
- SATA, CompactFlash socket,
- 2x mini PCIe, SIM card supported for GPRS/3G module
- Gb/s Ethernet, 8x USB 2.0 ports, 2x COM, VGA, 24-bits LVDS
- Watchdog Timer, Hardware Monitor

■ Product Specifications

CPU Support	Intel® Atom™ N270
Chipset	Intel® 945GSE + ICH7-M
Memory	1x DDR2 400/533 SO-DIMM Socket, up to 2GB
BIOS	AMI Plug & Play BIOS – 8Mb SPI ROM
Display	Integrated on Intel® 945GSE Chipset 18/24-bit Dual channel LVDS support 1x VGA
LAN	1x RJ-45, Gigabit Ethernet
Audio	HD Codec ALC662 with 2W Audio Amplifier Supports Line-in, Line-out & Microphone
Peripheral Support	2x SATA (one with onboard power connector) 1x CompactFlash socket 8x USB 2.0 2x COMs with Power Selection 4x DI/DO
Power Connector	ATX-4P
Expansion	Two MiniPCI Express socket
Watchdog Timer	1-255 step
Hardware Monitor	Operating voltage, CPU temperature and fan speed
Dimensions	ECX Embedded Board (105 x 146 mm)
Environmental Factors	Operation Temp: 0°C - 60°C Storage Temp.: -10°C - 85°C Humidity: 0% - 90%
Certifications	CE, FCC Class A

Table 2 KEEX-2130 Specification

■ System Block Diagram

• Block Diagram

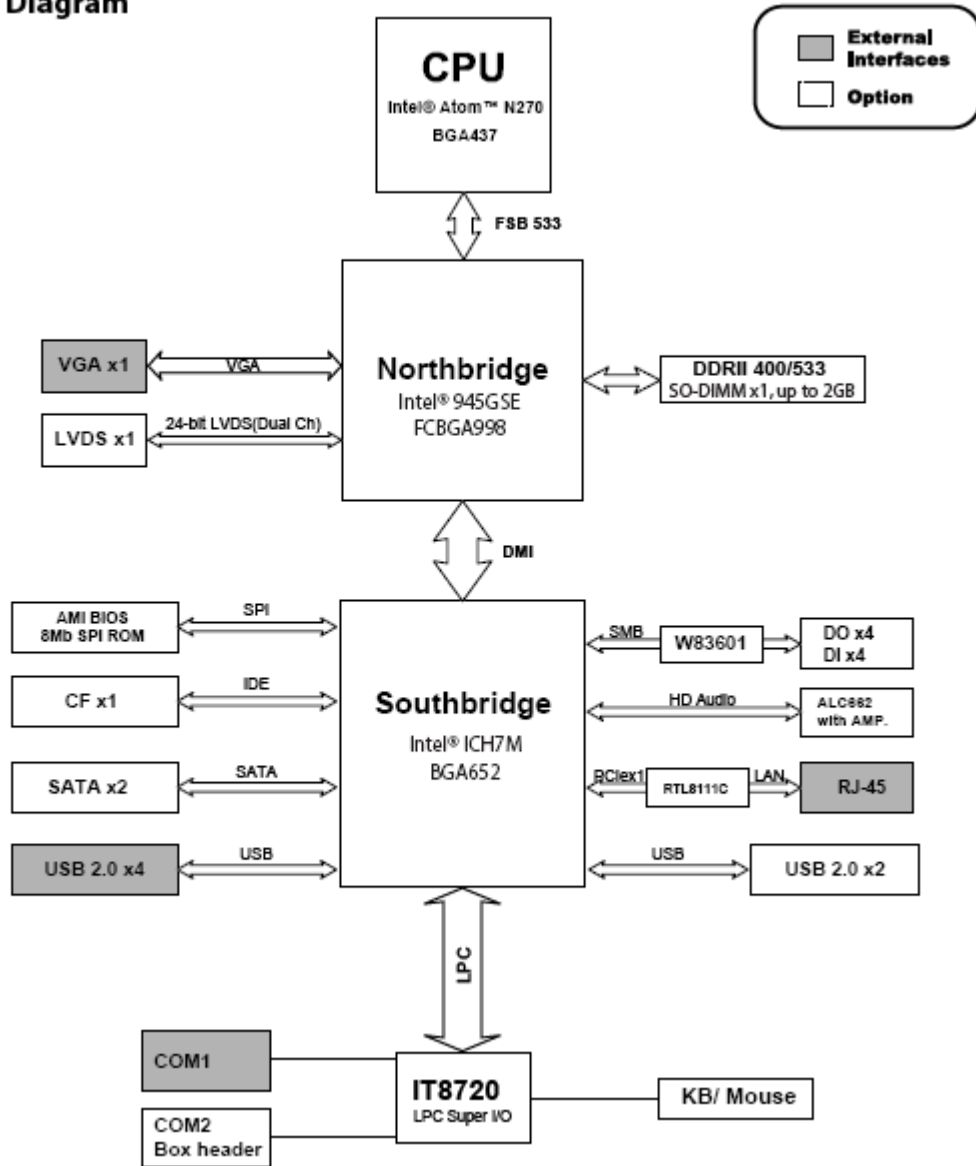

Figure 1 Block Diagram

■ Mechanical Dimensions

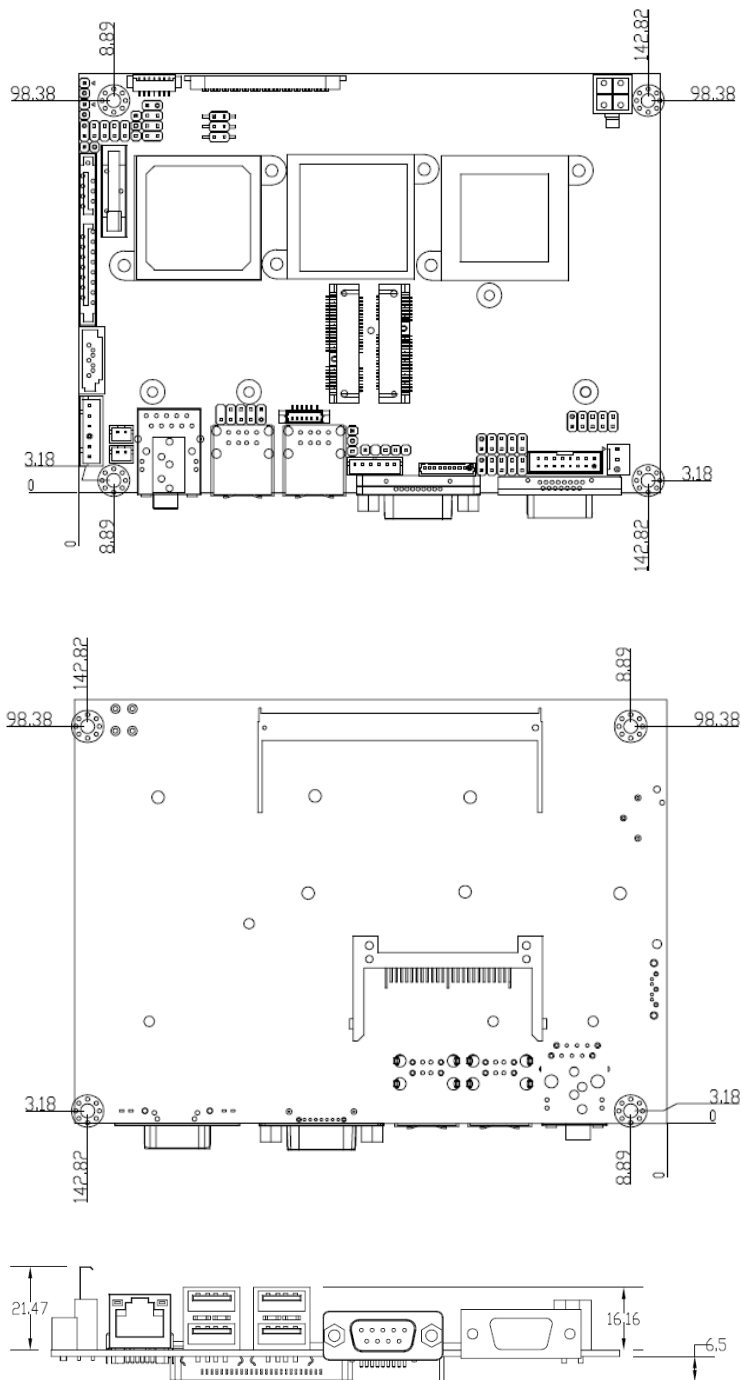

Figure 2 Mechanical Dimensions

Chapter 2

Hardware Settings

■ Overview

This chapter provides the definitions and locations of jumpers, headers, and connectors.

Jumpers

The product has several jumpers which must be properly configured to ensure correct operation.

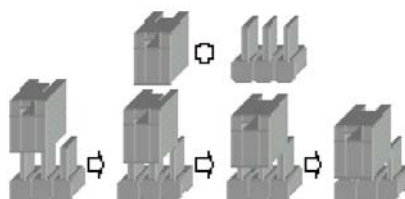

Figure 3 Jumper Connector

For a three-pin jumper (see *figure above*), the jumper setting is designated “1-2” when the jumper connects pins 1 and 2. The jumper setting is designated “2-3” when pins 2 and 3 are connected and so on. You will see that one of the lines surrounding a jumper pin is thick, which indicates pin No.1.

To move a jumper from one position to another, use needle-nose pliers or tweezers to pull the pin cap off the pins and move it to the desired position.

■ Jumper Settings and Pin Definitions

For jumper and connector locations, please refer to the diagrams below.

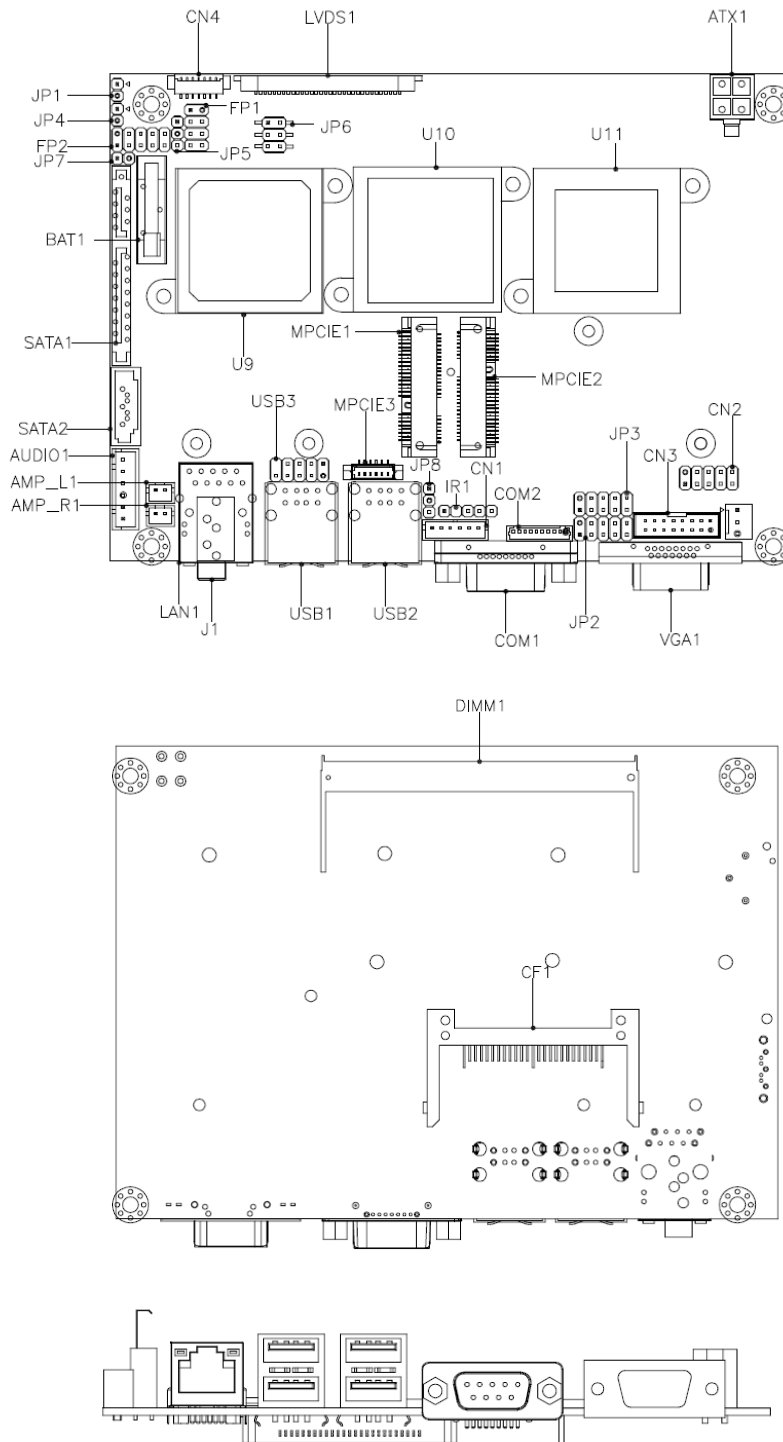

Figure 4 Jumper and Connector Locations

Jumper Settings

To ensure correct system configuration, the following section describes how to set the jumpers to enable/disable or change functions. For jumper descriptions, please refer to the table below.

Table 2 Jumper List

Label	Function
JP2	COM1 Signal / Power Selection
JP3	COM2 Signal / Power Selection
JP4	Clear CMOS Selection
JP5	Backlight Enable Selection
JP6	Backlight & Panel Power Selection
JP7	AT/ATX Power Mode Selection
JP8	Mini-PCIE Revision Selection

Table 3 JP2, JP3:COM Port Signal / Power Selection

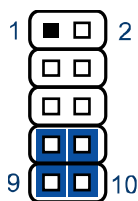

Jumper	Setting	Function
1	1-3 Short	Pin 1 = +12V
	3-5 Short	Pin 1 = +5V
	5-7 Short	Pin 1 = +5V
	7-9 Short	Pin 1 = DCD@RS232, TX+@RS422, RTX+@RS485
2	2-4 Short	Pin 8/9 = +12V
	4-6 Short	Pin 8/9 = +5V
	6-8 Short	Pin 8/9 = +5V
	8-10 Short	Pin 8/9 = RI

DIP 10P 2R MALE STRAIGHT TYPE Pitch:2.54mm [YIMTEX 3322*05SAGR(6T)]

Table 4 JP3: Clear CMOS Selection

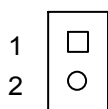

Jumper	Status
Open	Normal Operation
Short	Clear CMOS

Pitch:2.54mm [YIMTEX 3321*02SAGR(6T)]

Table 5 JP5:Backlight Enable Selection

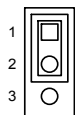

Jumper	Status
1-2	Active High
2-3	Active Low

Pitch:2.0mm [YIMTEX 3291*03SAGR(6T)]

Table 6 JP6: Backlight & Panel Power Selection

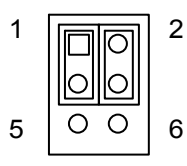

Jumper	Setting	Status
1	1-3	Backlight Power = +12V
	3-5	Backlight Power = +5V
2	2-4	Panel Power = +3.3V
	4-6	Panel Power = +5V

Pitch:2.54mm [YIMTEX 3362*03SAGR]

Table 7 JP7: Power Mode Selection

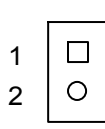

Jumper	Status
Open	ATX Mode
Short	AT Mode

Pitch:2.54mm [YIMTEX 3321*02SAGR(6T)]

Table 8 JP8: Mini-PCIE Revision Selection

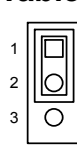

Jumper	Status
1-2	V1.1
2-3	V1.2

Pitch:2.0mm [YIMTEX 3291*03SAGR(6T)]

Rear Panel Pin Assignments

Table 9 Rear Panel Connector List

Label	Function
LAN1	10/100/1000 Ethernet RJ-45 Connector
USB1	USB2.0 Port 2 , 3 Type A Connector
USB2	USB2.0 Port 2 , 3 Type A Connector
COM1	RS-232 Port A DB-9 Connector
VGA1	VGA DB-15 Connector

Table 10 LAN1: 10/100/1000 Ethernet RJ-45 Connector (KEEX-2130)

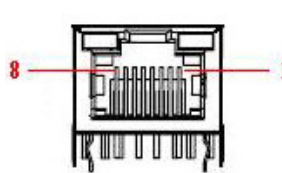

Pin	Signal Name	Pin	Signal Name
1	MDI 0+	2	MDI 0-
3	MDI 1+	4	MDI 1-
5	MDI 2+	6	MDI 2-
7	MDI 3+	8	MDI 3-

LAN LED	Function
Yellow	LINK / ACTIVE
OFF / GREEN / ORANGE	10 / 100 / 1000(Speed)

RJ45+TFM+LED 10/100/1000 14P DIP 90° [UDE RT7-174AAM1A(XA)]

Table 11 J1:Audio phone jack(KEEX-2131)

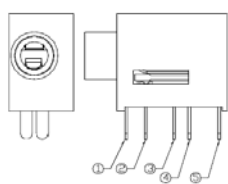

Pin	Signal
1	GND
2	L_OUT_L
3	GND
4	L_OUT_R
5	NC

JACK DIP 5 PIN, GREEN [KUON YI PJ-2508PC-5-L]

Table 12 USB1,USB2: 2-Stack USB2.0 Type A Connector

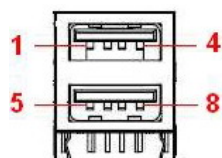

Pin	Signal Name	Pin	Signal Name
1	+5V	5	+5V
2	USB1-	6	USB0-
3	USB1+	7	USB0+
4	GND	8	GND

USB DIP 4*2P 90D [FOXCONN UB11123-8D1-4F]

Table 13 COM1: RS-232 Port 1 DB-9 Connector

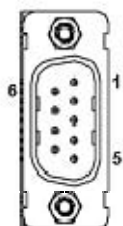

Pin	RS-232	RS-422	Half Duplex	Full Duplex
			RS-485	RS-485
1	DCD	TX-	DATA-	TX-
2	RXD	RX+	NA	RX+
3	TXD	TX+	DATA+	TX+
4	DTR	RX-	NA	RX-
5	GND	GND	GND	GND
6	DSR	NA	NA	NA
7	RTS	NA	NA	NA
8	CTS	NA	NA	NA
9	+5V/+12V/R I	+5V/+12V/N A	+5V/+12V/N A	+5V/+12V/N A

9Pin 90 度 Color : Green/for PC99 W/SCREW 螺帽=4.8mm，螺絲總長=9.5mm [芬瑩 SM1001P01012PN]

Note 1 : RS-232 / 422 / 485 can be selected in BIOS setup.

Table 14 VGA1:CRT DB-15 Connector

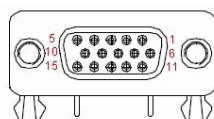

Signal Name	Pin	Pin	Signal Name
Red	1	2	Green
Blue	3	4	NC
GND	5	6	GND
GND	7	8	GND
VCC	9	10	GND
NC	11	12	DDC data
HSYNC	13	14	VSYNC
DDC clock	15		

D-SUB 15P DIP (F) 90D H/D CONNECTOR Blue 附六角螺絲 [芬瑩 SM1003S01012PN]

Main Board Pin Assignments

Table 15 Connector List

Label	Function
ATX1	+12V Power Input Connector
JP1	Wireless LAN LED
CN1	PS/2 KB/MS Output Wafer
CN2	Digital Input / Output Box Header
CN3	VGA Box Header
CN4	LCD Inverter Output Wafer
DIMM1	DDR2 Memory SO-DIMM Socket
FP1	Front Panel 1 Pin Header
FP2	Front Panel 2 Pin Header
LVDS1	LVDS Panel Connector
AUDIO1	CD-ROM Audio Input Wafer
MPCIE1	Mini PCIE slots
MPCIE2	Mini PCIE slots
USB3	USB2.0 Port 4, 5 Pin Header
CFD1	CF Type II Connector
SATA1	Serial ATA & HDD Power Connector
SATA2	Serial ATA Connector
AMP_R1	Audio AMP Right Output Wafer (KEEX-2130 Only)
AMP_L1	Audio AMP Left Output Wafer (KEEX-2130 Only)
FAN1	System FAN Wafer
COM2	RS-232 Port B With Power Wafer

Connector Pin Assignment

Table 16 ATX1:+12V Power Input Connector

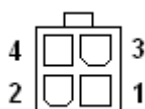

Pin	Signal Name
1	GND
2	GND
3	+12V
4	+12V

Pitch:4.2mm 空心 PIN [YIMTEX 576MWA2*02STR]

Table 17 JP1:Wireless LAN LED

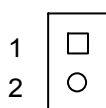

Jumper	Status
1	+3.3VSB
2	LED_WLAN#

Pitch:2.54mm [YIMTEX 3321*02SAGR(6T)]

Table 18 CN1:PS/2 KB/MS Output Wafer



Pin	Signal Name
1	MSCLK
2	VCC
3	MSDAT*
4	KBDAT
5	GND
6	KBCLK

Pitch=2.0mm 6P MALE 1R 180D [STM M24266]

Table 19 CN2:Digital Input / Output Pin Header(KEEX-2130)

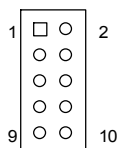

Pin	Signal	Pin	Signal
1	Digital Output 0	2	Digital Input 0
3	Digital Output 1	4	Digital Input 1
5	Digital Output 2	6	Digital Input 2
7	Digital Output 3	8	Digital Input 3
9	+5V	10	GND

DIP 10P 2R MALE STRAIGHT TYPE Pitch:2.54mm [YIMTEX 3322*05SAGR(6T)]

Table 20 CN2:Digital Input / Output Pin Header(KEEX-2131)

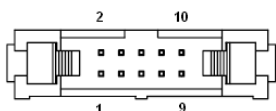

Pin	Signal	Pin	Signal
1	Digital Output 0	2	Digital Input 0
3	Digital Output 1	4	Digital Input 1
5	Digital Output 2	6	Digital Input 2
7	Digital Output 3	8	Digital Input 3
9	+5V	10	GND

Pitch:2.54mm 10P 2R MALE 180° 牛角[PINREX 51F-70-10GB01]

Table 21 CN3 VGA BOX HEADER

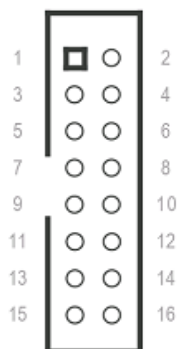

Pin	Signal	Pin	Signal
1	RR	2	GG
3	BB	4	GND
5	GND	6	VGAPWR
7	GND	8	GND
9	VGAPWR	10	GND
11	GND	12	SD_DATA
13	VGA_HSYNC	14	VGA_VSYNC
15	SD_CLK	16	GND

Pitch:2.0mm DIP 16P 2R 180D [PINREX 52S-90-16GB00]

Table 22 CN4:LCD Inverter Output Wafer

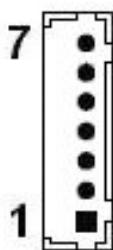

Pin	Signal Name
1	NC
2	BL_ADJ
3	GND
4	+5V / +12V **
5	+5V / +12V **
6	GND
7	BL_EN / BL_EN# *

Pitch:1.25mm 7P 90D WAFER [YIMTEX 501MW1*07MTRR]

* : Selected by JP5.

** : Selected by JP6.

Table 23 DIMM1:DDR2 Memory SO-DIMM Socket

SO DIMM 200P DDR2 1.8V H:6.5mm STD TYPE [FOXCONN AS0A426-N6SN-4F]

Table 24 FP1:Front Panel 1 Pin Header

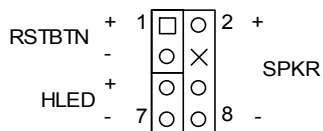

Pin	Signal	Pin	Signal
1	Reset Button +	2	Speaker +
3	Reset Button -	4	NC
5	HDD LED +	6	NC
7	HDD LED -	8	Speaker -

Pitch:2.54mm [YIMTEX 3322*04SAGR(6T)]

Table 25 FP2:Front Panel 2 Pin Header

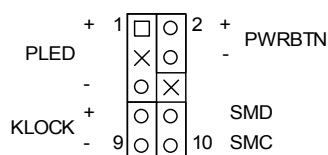

Pin	Signal	Pin	Signal
1	Power LED +	2	Power Button +
3	NC	4	Power Button -
5	Power LED -	6	NC
7	Keyboard Lock	8	SMBus Data
9	GND	10	SMBus Clock

DIP 10P 2R MALE STRAIGHT TYPE Pitch:2.54mm [YIMTEX 3322*05SAGR(6T)]

Table 26 LVDS1:LVDS Panel Connector



Pin	Signal Name	Pin	Signal Name
1	LVDS_A0-	16	LVDS_B1+
2	LVDS_A0+	17	GND
3	LVDS_A1-	18	LVDS_B2-
4	LVDS_A1+	19	LVDS_B2+
5	LVDS_A2-	20	LVDSBCLK-
6	LVDS_A2+	21	LVDS_BCLK+
7	GND	22	LVDS_B3-/NC
8	LVDS_ACLK-	23	LVDS_B3+/NC
9	LVDS_ACLK+	24	GND
10	LVDS_A3-/NC	25	JILI_DAT
11	LVDS_A3+/NC	26	VDDEN
12	LVDS_B0-	27	JILI_CLK
13	LVDS_B0+	28	+3.3V / +5V *
14	GND	29	+3.3V / +5V *

15	LVDS_B1-	30	+3.3V / +5V *
----	----------	----	---------------

Pitch:1mm 30P 90° 1R [JAE FI-X30SSL-HF]

Table 27 AUDIO1:CD-ROM Audio Input Wafer



Pin	Signal Name
1	LOUT_R
2	AUG(GND)
3	LOUT_L
4	LIN_R
5	MIC
6	LIN_L

Pitch:2.5mm DIP 6P 180° WAFER [YIMTEX 510XW1*06STR]

Table 28 MPCIE1,MPCIE2:Mini PCIE slots

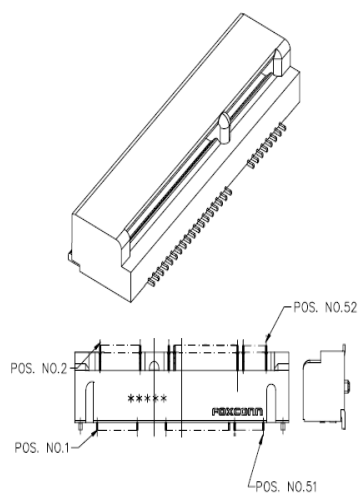

Signal Name	Pin	Pin	Signal Name
PCIE_WAKE#	1	2	+3.3VSB
NC	3	4	GND
NC	5	6	+1.5V
NC	7	8	*UIM_PWR/NC
GND	9	10	*UIM_DATA/NC
CLK100_MPCIE1#/2#	11	12	*UIM_CLK/NC
CLK100_MPCIE1/2	13	14	*UIM_RESET/NC
GND	15	16	*UIM_VPP/NC
NC	17	18	GND
NC	19	20	MPCIE1/2_EN
GND	21	22	RST_PCIE#
PCIE_RX2-/3-	23	24	+3.3VSB
PCIE_RX2+/3+	25	26	GND
GND	27	28	+1.5V
GND	29	30	SB_SMB_CLK
PCIE_TX2-/3-	31	32	SB_SMB_DAT
PCIE_TX2+/3+	33	34	GND
GND	35	36	USB6N/7N
GND	37	38	USB6P/7P
+3.3VSB	39	40	GND
+3.3VSB	41	42	LED_WLAN#
GND	43	44	LED_WLAN#
NC	45	46	LED_WLAN#
NC	47	48	+1.5v
NC	49	50	GND
NC	51	52	+3.3VSB

SMD PCIE 52P 90D(F) MINI PCI-Express Connector [FOXCONN AS0B226-S56N-7F]

SMD COLUMN M2.5 THREADS C.L=4.5mm STANDOFF=3mm [湘鐸 BOB398.0BM]

Table 29 MPCIE3 SIM card Wafer

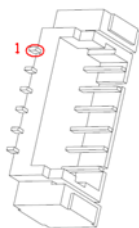

Pin	Signal Name
1	UIM_PWR
2	UIM_VPP
3	UIM_DATA
4	UIM_CLK
5	UIM_RESET
6	GND

P-1.25mm WAFER [Pinrex 712-73-06TWE0]

Table 30 USB3:USB2.0 Port 4, 5 Pin Header

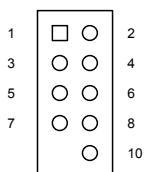

Pin	Signal Name	Pin	Signal Name
1	+5V	2	+5V
3	USB4-	4	USB5-
5	USB4+	6	USB5+
7	GND	8	GND
9	KEY	10	GND

Pitch:2.54mm (將 YIMTEX 3322*05SAGR(6T)第 9 pin 抽掉) [YIMTEX 3322*05SAGR(6T) -09]

Table 31 CFD1: CF Type II Connector

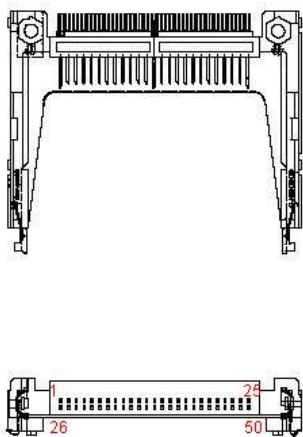

Signal Name	Pin	Pin	Signal Name
GND	1	26	GND
IDE Data 3	2	27	IDE Data 11
IDE Data 4	3	28	IDE Data 12
IDE Data 5	4	29	IDE Data 13
IDE Data 6	5	30	IDE Data 14
IDE Data 7	6	31	IDE Data 15
IDE Chip select 1#	7	32	IDE Chip select 3#
GND	8	33	GND
GND	9	34	IDEIOR#
GND	10	35	IDEIOW#
GND	11	36	+5V
GND	12	37	IDEIRQ
+5V	13	38	+5V
GND	14	39	PCSEL
GND	15	40	NC
GND	16	41	Reset IDE
GND	17	42	IDEIORDY
SDA2	18	43	DREQ
IDE Address 1	19	44	DACK#
IDE Address 0	20	45	IDE activity
IDE Data 0	21	46	PDIAG#
IDE Data 1	22	47	IDE Data 8
IDE Data 2	23	48	IDE Data 9
IOIS16#	24	49	IDE Data 10
GND	25	50	GND

CF SMD MALE 50P90D 2R stand-off 2mm, Standard type[晉祥 CF1A-71041-00E01]

Table 32 SATA1: Serial ATA & HDD Power Connector

	Pin	Signal Name	Pin	Signal Name
	S1	GND	P5	GND
	S2	TX+	P6	GND
	S3	TX-	P7	+5V
	S4	GND	P8	+5V
	S5	RX-	P9	+5V
	S6	RX+	P10	GND
	S7	GND	P11	GND
	P1	+3.3V	P12	GND
	P2	+3.3V	P13	+12V
	P3	+3.3V	P14	+12V
	P4	GND	P15	+12V

DIP 7P+15P MALE 180D SATA CONNECTOR BLACK [WIN WIN WATH-22DLBGU4]

Table 33 SATA2: SATA Connector

	Pin	Signal Name
	1	GND
	2	TX+
	3	TX-
	4	GND
	5	RX-
	6	RX+
	7	GND

DIP 7P 180D SATA CONNECTOR BLUE [FOXCONN LD1807V-S52U]

Table 34 AMP_R1: Audio AMP Right Output Wafer

	Pin	Signal Name
	1	Speaker+
	2	Speaker-

Pitch=2.0mm 2P 180° WAFER [YIMTEX 503PW1*02STR]

Table 35 AMP_L1: Audio AMP Left Output Wafer

	Pin	Signal Name
	1	Speaker+
	2	Speaker-

Pitch=2.0mm 2P 180° WAFER [YIMTEX 503PW1*02STR]

Table 36 FAN1:FAN Wafer

	Pin	Signal
	1	GND
	2	+12V
	3	FAN_RPM

Pitch:2.54mm WAFER [YIMTEX 521AW1*03STR]

Table 37 COM2: RS-232 Port B Wafer

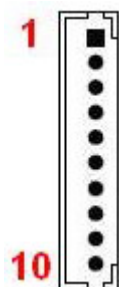

Pin	RS-232	RS-422	Half Duplex RS-485	Full Duplex RS-485
1	DCD	TX-	DATA-	TX-
2	DSR	NA	NA	NA
3	RXD	RX+	NA	RX+
4	RTS	NA	NA	NA
5	TXD	TX+	DATA+	TX+
6	CTS	NA	NA	NA
7	DTR	RX-	NA	RX-
8	+5V/+12V/RI	+5V/+12V/NA	+5V/+12V/NA	+5V/+12V/NA
9	GND	GND	GND	GND
10	+5V	+5V	+5V	+5V

Pitch:1.54mm WAFER [YIMTEX 501MW1*10STR]

COM Port Cable 0C5019001000010L COM Port cable, 10-pin pitch=1.25mm to DB-9 connector, L=10cm

Note 1 : RS-232 / 422 / 485 can be selected in BIOS setup.

Note 2 : The function of pin 8 can be selected by JP3 (in BIOS setup)

Chapter 3

System Installation

■ Memory Module Installation

Carefully follow the steps below in order to install the DIMMs:

1. To avoid generating static electricity and damaging the SO-DIMM, ground yourself by touching a grounded metal surface or use a ground strap before you touch the SO-DIMM.
2. Do not touch the connectors of the SO-DIMM. Dirt or other residue may cause a malfunction.
3. Hold the SO-DIMM with its notch aligned with the memory socket of the board and insert it at a 30-degree angle into the socket.

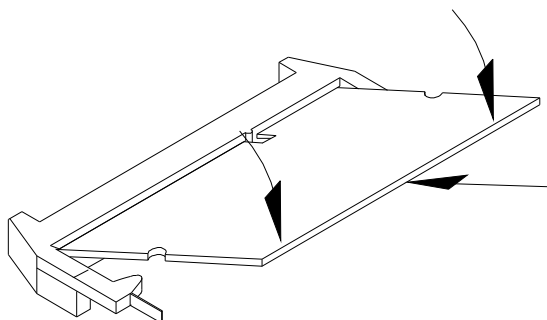

Figure 5 Align the SO-DIMM Memory Module with the onboard socket

4. Fully insert the module into the socket until a “click” is heard.
5. Press down on the SO-DIMM so that the tabs of the socket lock on both sides of the module

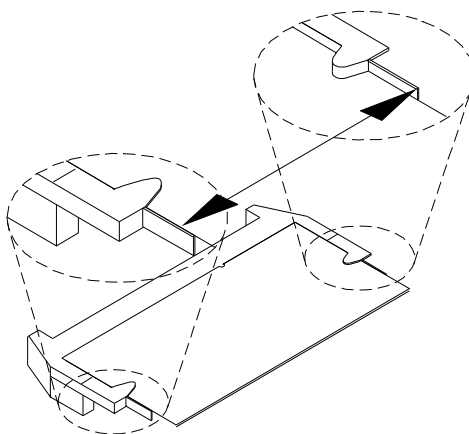

Figure 6 Press down on the SO-DIMM Memory Module to lock it in place

Removing a DIMM:

To remove the SO-DIMM, use your fingers or a small screwdriver to carefully push away the tabs that secure either side of the SO-DIMM. Lift it out of the socket.

Make sure you store the SO-DIMM in an anti-static bag. The socket must be populated with memory modules of the same size and manufacturer.

Chapter 4

AMI BIOS Setup

■ Overview

This chapter provides a description of the AMI BIOS. The BIOS setup menus and available selections may vary from those of your product. For specific information on the BIOS for your product, please contact Quanmax.



NOTE: The BIOS menus and selections for your product may vary from those in this chapter. For the BIOS manual specific to your product, please contact Quanmax

AMI's ROM BIOS provides a built-in Setup program, which allows the user to modify the basic system configuration and hardware parameters. The modified data will be stored in a battery-backed CMOS, so that data will be retained even when the power is turned off. In general, the information saved in the CMOS RAM will not need to be changed unless there is a configuration change in the system, such as a hard drive replacement or when a device is added.

It is possible for the CMOS battery to fail, which will cause data loss in the CMOS only. If this happens you will need to reconfigure your BIOS settings.

■ Main Menu

The BIOS Setup is accessed by pressing the DEL key after the Power-On Self-Test (POST) memory test begins and before the operating system boot begins. Once you enter the BIOS Setup Utility, the Main Menu will appear on the screen. The Main Menu provides System Overview information and allows you to set the System Time and Date. Use the “<” and “>” cursor keys to navigate between menu screens.

Table 38 BIOS Main Menu

BIOS SETUP UTILITY						
Main	Advanced	Boot	Chipset	Power	Security	Exit
System Date			[Mon 01/21/2008]			Use [ENTER], [TAB] or [SHIFT-TAB] to select a field.
System Time			[10:18:15]			
> SATA 1			: [Not Detected]			Use [+] or [-] to configure system Time.
> SATA 2			: [Not Detected]			
> CF			: [Not Detected]			
> System Information						<> Select Screen ↑↓ Select Item +- Change Field Tab Select Field F1 General Help F10 Save and Exit ESC Exit
V02.61 (C)Copyright 1985-2006, American Megatrends, Inc.						

Below table is described for SATA 1, SATA 2, CF setting.

Table 39 IDE Device Setting Menu

BIOS SETUP UTILITY						
Main						
Primary Master						Disable: Disables LBA Mode. Auto: Enables LBA Mode if the device supports it and the device is not already formatted with LBA Mode disabled.
Device			: [Not Detected]			
LBA/ Large Mode			[Auto]			<> Select Screen ↑↓ Select Item +- Change Field Tab Select Field F1 General Help F10 Save and Exit ESC Exit
DMA Mode			[Auto]			
S.M.A.R.T			[Auto]			
V02.61 (C)Copyright 1985-2006, American Megatrends, Inc.						

LBA/ Large Mode

Enables or disables the LBA (Logical Block Addressing)/ Large mode. Setting to Auto enables the LBA mode if the device supports this mode, and if the device was not previously formatted with LBA mode disabled. Options: Disabled, Auto

DMA Mode

Options: Auto, SWDMA, MWDMA, UDMA mode

S.M.A.R.T

SMART stands for Smart Monitoring, Analysis, and Reporting Technology. It allows AMIBIOS to use the SMART protocol to report server system information over a network. Options: Auto, Disabled, Enabled

Table 40 System Information

BIOS SETUP UTILITY	
Main	
AMIBIOS Version : 1.1 Build Date: :02/09/10 Processor Genuine Intel® CPU N270 @ 1.60GHz Speed :1600MHz Count :1 System Memory Size :1016MB	<> Select Screen ↑↓ Select Item +- Change Field Tab Select Field F1 General Help F10 Save and Exit ESC Exit
V02.61 (C)Copyright 1985-2006, American Megatrends, Inc.	

■ **Advanced Menu**

Table 41 Advanced Menu

BIOS SETUP UTILITY						
Main	Advanced	Boot	Chipset	Power	Security	Exit
Advanced Settings <hr/> Warning: Setting wrong values in below sections may cause system to malfunction. > I/O Configuration > OnBoard Peripherals Configuration > Hardware Health Configuration						<> Select Screen ↑↓ Select Item +- Change Field Tab Select Field F1 General Help F10 Save and Exit ESC Exit
V02.61 (C)Copyright 1985-2006, American Megatrends, Inc.						

Press <Enter> to select a sub-menu for detailed options.

Table 42 Onboard I/O Configuration

BIOS SETUP UTILITY	
Advanced	
Onboard I/O Configuration	Allow BIOS to Select Serial Port1 Base Address.
COM1 Address [3F8/IRQ4]	
COM1 Mode [Normal]	
COM1 Function Type [RS232]	
COM2 Address [2F8]	
COM2 Mode [Normal]	
COM2 Function Type [RS232]	
	<> Select Screen ↑↓ Select Item +- Change Field Tab Select Field F1 General Help F10 Save and Exit ESC Exit
V02.61 (C)Copyright 1985-2006, American Megatrends, Inc.	

COM1 Address

Options: Disabled, 3F8/IRQ4, 3E8/IRQ4, 2E8/IRQ3

COM1 Mode

Options: Normal, IrDA, ASK IR

COM1 Function Type

Options: RS232, RS422, RS485

COM2 Address

Options: Disabled, 3F8/IRQ4, 3E8/IRQ4, 2E8/IRQ3

COM 2 Mode

Options: Normal, IrDA, ASK IR

COM2 Function Type

Options: RS232, RS422, RS485

Table 43 OnBoard Peripherals Configuration Settings

BIOS SETUP UTILITY		
Advanced		
OnBoard Peripherals Configuration Settings		Options
USB Controller	[Enabled]	Disabled
USB 2.0 Controller	[Enabled]	Enabled
USB Device Legacy Support	[Enabled]	
Audio Controller	[Enabled]	
Onboard LAN Controller	[Enabled]	<> Select Screen
Onboard LAN OPTROM	[Disabled]	↑↓ Select Item
		+ - Change Field
		Tab Select Field
		F1 General Help
		F10 Save and Exit
		ESC Exit
V02.61 (C)Copyright 1985-2006, American Megatrends, Inc.		

USB Controller

Options: Enabled, Disabled

USB 2.0 Controller

Options: Enabled, Disabled

USB Device Legacy Support

Options: Enabled, Disabled, Auto

Audio Controller

Options: Enabled, Disabled

Onboard LAN Controller

Options: Enabled, Disabled

Onboard LAN OPTROM

Options: Enabled, Disabled

Table 44 Hardware Health Configuration

BIOS SETUP UTILITY		
Advanced		
Hardware Health Configuration		
CPU Warning Temperature	[Disabled]	
CPU Shutdown Temperature	[Disabled]	
CPU Temperature	:52°C/ 192°F	
SYS Temperature	:42°C/ 129°F	
FAN 1 Mode Setting	[Full On mode]	
Fan Speed	:N/A	
+V CORE	:1.072 V	
+1.05V	:1.040 V	
+3.3V	:3.312 V	
+5V	:5.053 V	
+12V	:11.840 V	
+1.8v	:1.758 V	
+VCC RTC	:3.365 V	
<> Select Screen ↑↓ Select Item +- Change Field Tab Select Field F1 General Help F10 Save and Exit ESC Exit		
V02.61 (C) Copyright 1985-2006, American Megatrends, Inc.		

■ Boot Menu

Table 45 Boot Menu

BIOS SETUP UTILITY						
Main	Advanced	Boot	Chipset	Power	Security	Exit
Boot Settings <hr/> > Quick Boot [Enabled] > Bootup Num-Lock [ON] > Wait For 'F1' If Error [Enabled] > Hit 'DEL' Message Display [Enabled]					Allow BIOS to Skip certain tests while booting. This will decrease the time needed to boot the system. <> Select Screen ↑↓ Select Item +- Change Field Tab Select Field F1 General Help F10 Save and Exit ESC Exit	
V02.61 (C)Copyright 1985-2006, American Megatrends, Inc.						

Quick Boot

Enabling this item allows BIOS to skip some Power On Self Tests (POST) while booting to decrease the time needed to boot the system. When set to [Disabled], BIOS performs all the POST items.

Options: Disabled, Enabled

Bootup Num-Lock [On]

Allow you to select the power-on state for the NumLock.

Options: Off, On

Wait for 'F1' If Error [Enabled]

When set to Enabled, the system waits for F1 key to be pressed when error occurs.

Options: Disabled, Enabled

Hit 'DEL' Message Display [Enabled]

When set to Enabled, the system displays the message 'Press DEL to run Setup' during POST.

Options: Disabled, Enabled

■ Chipset Menu

Table 46 Chipset Menu

BIOS SETUP UTILITY						
Main	Advanced	Boot	Chipset	Power	Security	Exit
Chipset Settings				Options		
DRAM Frequency		[Auto]		Auto		
Configure DRAM Timing by SPD		[Enabled]		400 MHz		
Boots Graphic Adapter Priority		[PEG/PCI]		533 MHz		
Internal Graphics Mode Select		[Enabled, 8MB]		<> Select Screen		
Hyper Threading Technology		[Enabled]		↑↓ Select Item		
> Video Function Configuration				+- Change Field		
				Tab Select Field		
				F1 General Help		
				F10 Save and Exit		
				ESC Exit		
V02.61 (C)Copyright 1985-2006, American Megatrends, Inc.						

DRAM Frequency

Options: Auto, 400 MHz, 533MHz

Configure DRAM Timing by SPD

Options: Disabled, Enabled

Boots Graphic Adapter Priority

Select which graphics controller to use as the primary boot device.

Options: IGD, PCI/IGD, PCI/PEG, PEG/IGD, PEG/PCI

Internal Graphics Mode Select

Select the amount of system memory used by the Internal graphics device.

Options: Disabled, Enabled 1MB, Enabled 8M

Hyper Threading Technology

Options: Disabled, Enabled

Video Function Configuration

Table 47 Video Function Configuration

BIOS SETUP UTILITY	
Chipset	
Video Function Configuration	Options
DVMT Mode Select [DVMT Mode]	Fixed Mode
DVMT/FIXED Memory [128M]	DVMT Mode
Boot Display Device [Auto]	Combo Mode
Flat Panel Type [1024X768 24Bit 1C]	<> Select Screen
Local Flat Panel Scaling [Auto]	↑↓ Select Item
Panel BackLight Voltage [2.5]	+ - Change Field
	Tab Select Field
	F1 General Help
	F10 Save and Exit
	ESC Exit
V02.61 (C)Copyright 1985-2006, American Megatrends, Inc.	

DVMT Mode Select [DVMT Mode]

Options: Fixed Mode, DVMT Mode, Combo Mode

DVMT/FIXED Memory [128MB]

Options: 64MB, 128MB, Maximum DVMT

Boot Display Device [VGA]

Options: VGA, LVDS, VGA+LVDS

Flat Panel Type [1024x768 24Bit 2C]

Options:

1024x768 24Bit 1CH

1280x1024 24Bit 1CH

1366x768 24Bit 2CH

1920x1080 24Bit 2CH

Local Flat Panel Scaling [Auto]

Options: Auto, Forced Scaling, Disabled

Panel BackLight Voltage [2.5]

Options: Min 0.0V, Max: 5.0V

Power Menu

Table 48 Power Menu

BIOS SETUP UTILITY						
Main	Advanced	Boot	Chipset	Power	Security	Exit
Power Management Setting					Select the ACPI state used for System Suspend	
ACPI Function				[Enabled]		
Suspend mode				[S1 (POS)]		
Repost Video on S3 Resume				[No]	<> Select Screen	
Suspend Time Out				[Disabled]	↑↓ Select Item	
Restore on AC Power Loss				[Power Off]	+- Change Field	
Resume By USB Device				[Disabled]	Tab Select Field	
Resume On PME#				[Disabled]	F1 General Help	
Resume On RTC Alarm				[Disabled]	F10 Save and Exit ESC Exit	
V02.61 (C)Copyright 1985-2006, American Megatrends, Inc.						

ACPI Function

Enable/ Disable ACPI support for Operating System.

ENABLE: If OS supports ACPI, DISABLE: IF OS Does not support ACPI.

Suspend mode

Options: S1 (POS), S3 (STR)

Repost Video on S3 Resume

Determines whether to invoke VGA BIOS post on S3/STR resume.

Options: No, Yes

Suspend Time Out

Options: Disabled, 1 Min, 2 Min, 4 Min, 8 Min, 10 Min, 20 Min, 30 Min, 40 Min, 50 Min, 60 Min

Restore on AC Power Loss

Options: Power OFF, Power ON, Last State

Resume By USB Device

Options: Disabled, Enabled

Resume On PME#

Options: Disabled, Enabled

Resume On RTC Alarm

Options: Disabled, Enabled

■ Security Menu

Table 49 Security Menu

BIOS SETUP UTILITY						
Main	Advanced	Boot	Chipset	Power	Security	Exit
Security Setting Supervisor Password :Not Installed User Password :Not Installed Change Supervisor Password Change User Password					Install or Change the password. <> Select Screen ↑↓ Select Item +- Change Field Tab Select Field F1 General Help F10 Save and Exit ESC Exit	
V02.61 (C)Copyright 1985-2006, American Megatrends, Inc.						

Change Supervisor Password

Select this item to set or change the supervisor password. The Supervisor Password item on top of the screen displays the default Not Installed. After you have set a password, this item displays Installed.

Change User Password

Select this item to set or change the user password. The User Password item on top of the screen displays the default Not Installed. After you have set a password, this item displays Installed.

■ Exit Menu

Table 50 Exit Menu

BIOS SETUP UTILITY						
Main	Advanced	Boot	Chipset	Power	Security	Exit
Exit Setting					Exit System Setup after saving the changes.	
Save Changes and Exit					F10 key can be used for this operation.	
Discard Changes and Exit					<> Select Screen	
Discard Changes					↑↓ Select Item	
Load Optimal Defaults					+- Change Field	
Load Failsafe Defaults					Tab Select Field	
					F1 General Help	
					F10 Save and Exit	
					ESC Exit	
V02.61 (C)Copyright 1985-2006, American Megatrends, Inc.						

Save Changes and Exit

Exit system setup after saving the changes. Once you are finished making your selections, choose this option from the Exit menu to ensure the values you selected are saved to the CMOS RAM. The CMOS RAM is sustained by an onboard backup battery and stays on even when the PC is turned off. When you select this option, a confirmation window appears. Select [Yes] to save changes and exit.

Discard Changes and Exit

Exit system setup without saving any changes. Select this option only if you do not want to save the changes that you made to the Setup program. If you made changes to fields other than system date, system time, and password, the BIOS asks for a confirmation before exiting.

Discard Changes

Discards changes done so far to any of the setup values. This option allows you to discard the selections you made and restore the previously saved values. After selecting this option, a confirmation appears. Select [Yes] to discard any changes and load the previously saved values.

Load Optimal Defaults

Load Optimal Default values for all the setup values. This option allows you to load optimal default values for each of the parameters on the Setup menus, which will provide the best performance settings for your system. The F9 key can be used for this operation.

Load Failsafe Defaults

Load Optimal Default values for all the setup values. This option allows you to load failsafe default values for each of the parameters on the Setup menus, which will provide the most stable performance settings. The F8 key can be used for this operation.

Chapter 5

Driver Installation

If your KEEEX-2130 does not come with an operating system pre-installed, you will need to install an operating system and the necessary drivers to operate it. After you have finished assembling your system and connected the appropriate power source, power it up using the ATX Power Switch and install the desired operating system. You can download the drivers for the KEEEX-2130 from the Quanmax website at www.quanmax.com and install as instructed there. For other operating systems, please contact Quanmax.

NOTE



When the system reboots without connecting the CRT, there might be no image on screen when you insert the CRT/VGA cable. Please pressing **<Ctrl>+<Alt>+<F3>** simultaneously to show the image on screen.

Appendix A

DIO (Digital I/O) Sample Code

```
//=====
//KEEX-2130 DOS DIO sample program
//Please compile with Turbo C 3.0 to utilized the program
//=====
Int main(){
    //Output RetVal to Digital Output
    //Set all output to 1
    outp(0x48d, 0xF0); //DO0 is bit 4
                        //DO1 is bit 5
                        //DO2 is bit 6
                        //DO3 is bit 7

    //Set all output to 0
    outp(0x48d, 0x00);

    //Reading Digital input
    RetVal=inp(0x48c); //DI0 is bit 6
                    //DI1 is bit 7
    RetVal=inp(0x4B8); //DI2 is bit 6
    RetVal=inp(0x48d); //DI3 is bit 1
    Return 0;
}
```

Appendix B

WatchDog Timer Sample Code

```
//=====
//KEEX-2130 DOS Watchdog sample program
//Please compile with Turbo C 3.0 to utilized the program
//=====

int main()
{
//Initialized the WDT program
outp(0x2e,0x87);
outp(0x2e,0x01);
outp(0x2e,0x55);
outp(0x2e,0x55);

//Setting Logical Device Number to 0x07
outp(0x2e,0x07);
outp(0x2f,0x07);

outp(0x2e,0xf1);
outp(0x2f,0x44);

outp(0x2e,0xf4);
outp(0x2f,0xea);

//Set Timer Value(0x73 is LSB while 0x74 is MSB)
outp(0x2e,0x73);
outp(0x2f,0x14);//set to 20 sec (0x14)

//Set Timer Unit to Second/Minute(Bit 7 equal to 1 is second/0 is minute)
outp(0x2e,0x72);
outp(0x2f,0x80);//The unit is set as second
return 0;
}
```